

Data Sheet for T-Sc1400FC

Specifications	
Type :	Rechargeable Nickel Cadmium Fast Charge Cell
Model (P/N) :	T-Sc1400FC
Nominal Dimension : (with sleeve)	$\Phi = 22.5 \overset{0}{-0.5} \text{ mm}$ $H = 42.5 \pm 0.5 \text{ mm}$
Applications :	Recommended discharge current 140 mA to 1400 mA
Nominal Voltage :	1.2V
Nominal Capacity :	1400 mAh when discharge at 280 mA to 1.0 V at 20°C
Standard Charge :	280 mA for 7 hrs at 20°C
Fast Charge :	1300 mA (1 C) with charge termination control Recommended control parameters - ΔV :10 mV & $\Delta T / \Delta t$:0.8~1°C/min Timer: 150 % nominal input
Service Life :	> 500 cycles
Continuous Overcharge :	140 mA maximum permissible current No conspicuous deformation and / or leakage
Weight :	49 g
Internal Resistance :	Max 20 m Ω at 1000 Hz measured within 1 hour after standard charge
Max. Charging Voltage :	1.5 V at 280 mA charging
Ambient Temperature Range	Standard Charge : 0°C to 45°C Fast Charge : 10°C to 45°C Discharge : -20°C to 45°C Storage : -20°C to 45°C

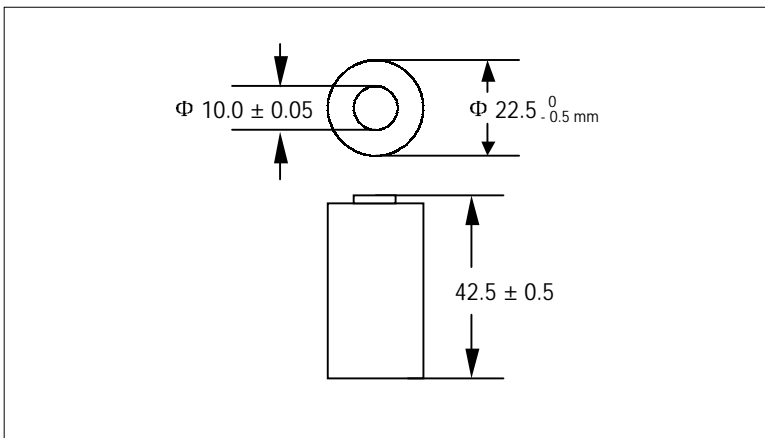

Characteristics

Charge Curves (20 °C)

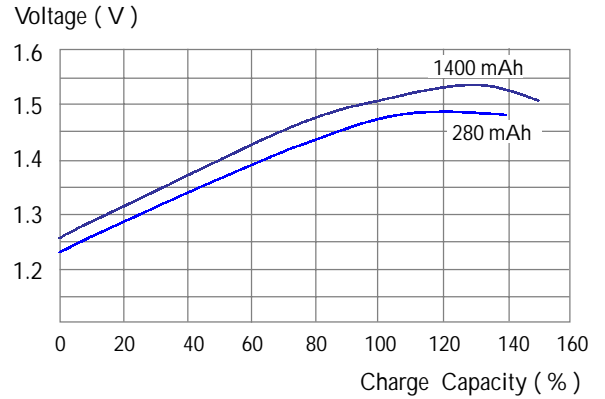

Discharge Curves (20 °C)

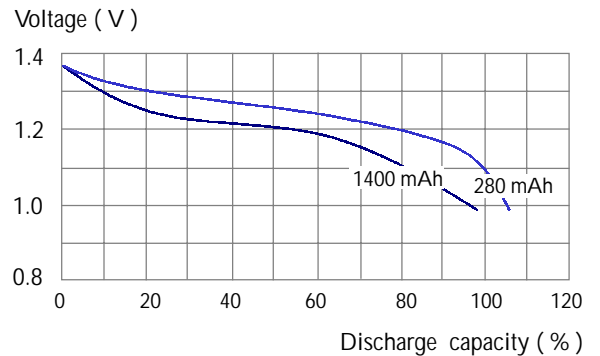

Charge/Discharge Efficiency vs. Temperature

